

# Stock Reference Guide

## NORDIC STRUCTURES

### NI-40X 2" X 3" Solid Flanges

Spans Up To  
9-1/2" - 17' 00"  
11-7/8" - 20' 03"

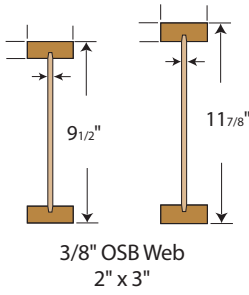

### NI-60 2" X 3" Solid Flanges

Spans Up To  
11-7/8" - 20' 8"  
14" - 23' 06"  
16" - 26' 00"

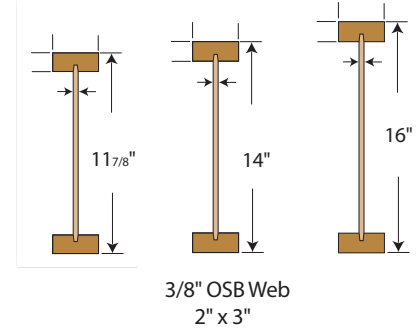

### NI-80 2" X 4" Solid Flanges

Spans Up To  
9-1/2" - 19' 01"  
11-7/8" - 22' 08"  
14" - 25' 09"  
16" - 28' 06"

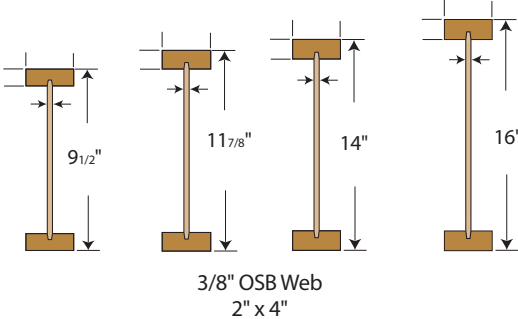

### NI-90 2" X 4" Solid Flanges

Spans Up To  
11-7/8" - 23' 06"  
14" - 26' 09"  
16" - 29' 08"

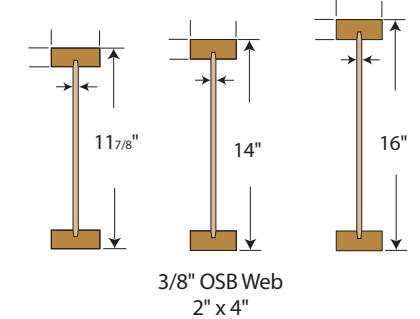

\*\*\*All spans base on typical residential 40/10 loading, I/480 16" O/C

## COASTAL PRO

### CPI-56 Series 3-1/2" X 1-1/2" LVL Flanges

Spans Up To  
11-7/8" - 24' 1"  
16" - 30' 01"

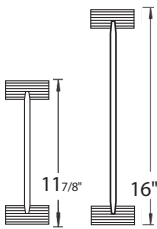

### CPI-36 Series 2-1/4" X 1-1/2" LVL Flanges

Spans Up To  
11-7/8" - 20' 08"



### 1-3/4" 2.1 E CP-Lam

Available Sizes (inches)  
3100Fb

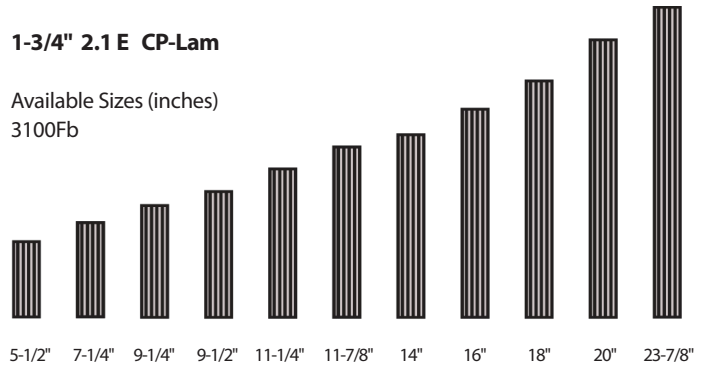

## PWT TREATED

## PWT FOCUSED ON EWP

### Treated 1-3/4" LVL

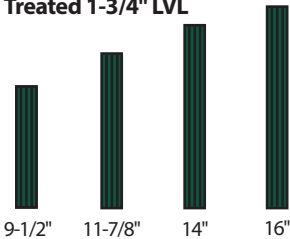

### Billet Beam

3-1/2" x 3-1/2" 8', 10'  
3-1/2" x 5-1/2" 8', 10'  
5-1/4" x 5-1/2" 8', 10', 12', 16', 20'  
5-1/4" x 7-1/4" 8', 10', 12', 16', 20'



### MEETS IRC FIRE CODES



COASTAL PRO



TEC 1.35e  
LSL PRODUCTS

### DOUG FIR LVL ENGINEERED FRAMING LUMBER

1-1/2" wide, 1.6 MOE

2x4 up to 20' lengths

2x6 up to 24" lengths

2x8 16', 20' & 24' lengths

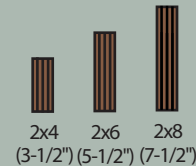

### PRE-CUT LSL STUDS 2x4 & 2x6

92-5/8"L, 104 5/8"L,  
116-5/8"L



### PRE-CUT LSL FRAMING LUMBER 2x4 8-10-12-16-20'

2x6 8-10-12-16-20-24'

2x8 20'

2x12 16-20-24-28'



## SIMPSON

Strong-Tie

Matching Connectors In-Stock!!!



# COASTAL

# Stock Reference Guide



24" TRIMMABLE

Maximum Size of Pipes, Ducts and Cable Trays Through Diagonal Web Members

Depth	Round D	Square W&H	Rectangular W&L
11"	7¼"	5¾" x 5¾"	3" x 13"
14"	8½"	6½" x 6½"	3" x 14", 6" x 8"
16"	9½"	7½" x 7½"	3" x 15"

11-7/8" – up to 22'    14" – up to 26'    16" – up to 30'  
 \*Meets 1st Floor Firecode r501.3

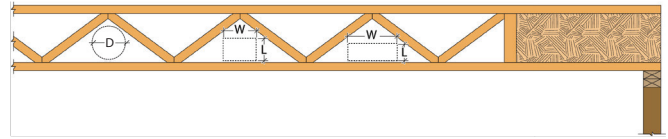

## Rim Board Plus

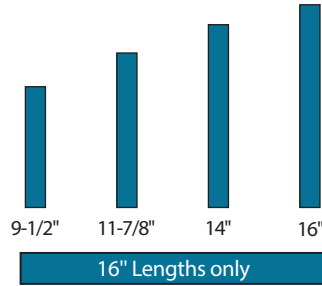
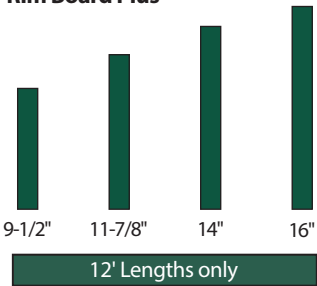

## ADDITIONAL SERVICES

- Full Stocking Inventory for Prompt Delivery
- Job-site Delivery Available\*
- In-house Design Specialists
- Prompt Turnaround for Drawings
- Commercial Joists - Architectural Glu lams Available
- Stamped Calcs Available\*
- iStruct® Software Available\*
- In-House/On-site Training\*

\*See Coastal Rep for more details



## Power Beam®

2.1 MOE / 3000Fb / 25 Year Warranty

### 3-1/2" Wide

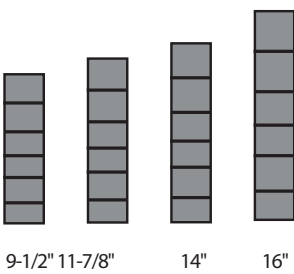

### 5-1/2" Wide

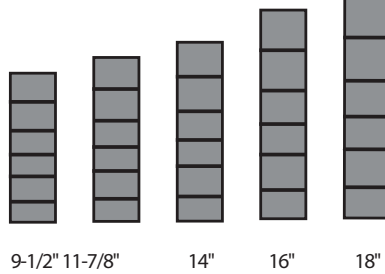

### 7" Wide

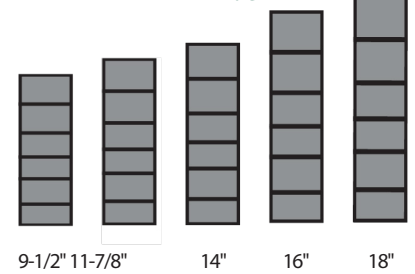

## Power Preserved Glulam™ – 1.8 MOE / 2400Fb

### 3-1/2" Wide

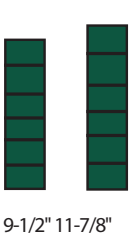

### 5-1/4" Wide

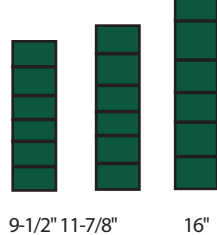

## Power Column® – 1.9 MOE / 2400Fb

### 3-1/2" Wide



### 5-1/2" Wide

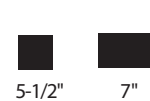

### 7" Wide



## Power Preserved Column® – 1.9 MOE / 2100Fb

### 5-1/2" Wide



Stocked at Coastal Forest Products Up to 28' Lengths  
 5-1/4" x 5 1/2" - up to 28'

